



OPERATORS MANUAL

LOAD KING

4000 GALLON WATER TANK

REV A

JULY 2, 2018

Table of Contents

INTRODUCTION.....	3
DEFINITIONS USED IN THIS MANUAL.....	4
OPERATORS MANUAL.....	5
PRE-USE INSPECTION.....	5
PROPER OPERATION SEQUENCE.....	5
POST OPERATION INSPECTION.....	7
SAFETY INFORMATION.....	8
LOAD KING WATER TANK LABELS.....	9
LUBRICATION AND MAINTENANCE.....	11
LOAD KING WARRANTY.....	13
LIMITATION OF LIABILITY.....	13
LOAD KING WARRANTY DATA RECORD.....	14
REVISION CONTENT.....	15

Company

Load King has been producing quality trailers since 1956. We are located in Elk Point, South Dakota.

Although the trailer industry is an ever-changing environment and we've seen many changes over the years, we have remained committed to the simple philosophy that we will make a reasonable profit through the designing, manufacturing, and marketing of top quality products that we can always be proud to call Load King. We have not, and will not, compromise in this area.

Quality shows in all facets of an operation, from the moment you make your first phone call for a product inquiry to the time you sell your used equipment and realize you've received top dollar on your sale. We continue to strive for excellence in every area and never quit trying to improve. We have earned our reputation believing that quality is value and value sells products.

Through our shared Engineering, Marketing and Sales teams, Load King and Custom Truck One Source bring that tradition of quality and value to another market with the Load King Water Truck.





About Custom Truck One Source

Beginning in February of 2015, three family-owned and operated companies (Custom Truck & Equipment, Utility Fleet Sales and Forestry Equipment of VA) joined together to form what is now Custom Truck One Source. Shortly after its inception, UCO Equipment became a part of the CTOS family along with TNT Equipment six months later. In December 2015, CTOS welcomed its sixth company under its brand, Load King, a leading manufacturer of high-quality and customizable trailers.

The announcement of the partnership represented the platform's collective commitment to the continued growth and dominance of each legacy company's individual offerings, now compounded to leverage the expertise of the team and, ultimately, better serve loyal CTOS customers all over the world. CTOS will build upon the market positions of each legacy company, while serving as a single source supplier of specialty equipment and services for the utility and heavy equipment industries. The utility and heavy equipment platform collectively offers sales, rentals, parts and after market services, remanufacturing, customized equipment and transportation.

Definitions Used in this Manual

The following table describes text and symbols used to highlight important information.

Signal Word	Symbol	Explanation
DANGER		Danger is used to alert readers about an immediate and serious hazard that will likely be fatal.
WARNING		Warning is used to alert readers about the potential for serious injury or death or serious damage to equipment.
CAUTION		Caution is used to alert readers about the potential for anything from moderate injury to serious equipment damage or destruction.
READ		Read is used to alert readers of information to be read on machinery
NOTE		Note is used for a tip or suggestion to help readers carry out a procedure successfully.

Table—1

OPERATORS MANUAL



When using a Load King Water Tank, it is important to have a good understanding of the proper pre-inspection, post-inspections, and operating guidelines. By following these steps, you can safely operate the Load King Water Tank with minimal risks of damage to the machine or the surrounding property.

Pre-Use Inspection

1. Before using a Load King Water Tank, do a 360 degree walk around to visually inspect that your surroundings will be free of obstructions once in operation.
2. Check the water level of the tank prior to operation.
3. Visually inspect all critical fasteners to ensure there are no loose or damaged bolts, nuts, or other hardware. Ensure that all lubrication points have been well maintained and lubricated.
4. If any damage to body or hardware is observed, do not operate until a thorough inspection has been conducted and all necessary repairs have been made.

Mobile Operations Sequence

Activating:



1. **CAUTION:** Before opening the spray valve(s), check your surroundings and ensure all bystanders are kept away from the area of operation.

2. Select the desired spray valve(s) and place the switch in the on position to open the valve(s).
3. Use the PTO selector switch to engage the PTO for mobile operation, shift the truck into drive and operate the truck normally.



4. **CAUTION:** Do not exceed the recommended RPM. If recommended RPM is exceeded, The PTO will disengage and will not re-engage until the engine drops below 1000 RPM.

De-activating:

1. Slow down to under 1000 RPM and disengage the PTO.



2. **WARNING:** Do not close the valves before the PTO has been disengaged. The spray valves should never be closed while the PTO is engaged and the system is under pressure.

3. Close the spray valve(s).

OPERATORS MANUAL (Cont.)

Water Hose Operation Sequence

1. While the truck is in park, engage the parking brake and start the engine.
2. Use the PTO selector switch to engage the PTO for stationary operation.
3. Unravel the desired amount of hose from the rear of the truck, and open the ball valve located above the hose reel by placing the handle in-line with the valve.



4. **WARNING:** Fully secure the hose BEFORE opening the hose nozzle, and check your surroundings to ensure all bystanders are kept away from the area of operation.



5. **CAUTION:** The throttle switch will cause the pump to operate at a higher RPM which will create more pressure.

6. Open the hose nozzle and activate the high RPM toggle switch to speed up the pump.
7. Adjust the spray by turning the hose nozzle either clockwise or counter clockwise.
8. Use the throttle switch to lower the RPM, and then completely close the hose nozzle.
9. Reel in the hose and close the ball valve.
10. Disengage the PTO.

Hydrant Fill Sequence

1. With the truck in park and parking break on, connect the source hose to the hydrant nipple at the rear of the truck.
2. Turn on the source and fill to the desired level, then turn off the source.
3. Disconnect the source hose.

Creek Fill Sequence

1. While the truck is in park, engage the parking brake and start the engine.
2. Connect the fill hose to the creek nipple.
3. Submerge the other end of the hose into the water supply.
4. With valve (B) closed, open valves (A) and (C).
5. Open valve (B) and allow the suction hose to fill from the tank.
6. Engage the PTO for mobile use.
7. Close valve (C) and allow the tank to fill.

OPERATORS MANUAL (Cont.)

8. Turn off the PTO.
9. Close valves (A) and (B), and open valve (C).
10. Disconnect and stow the fill hose

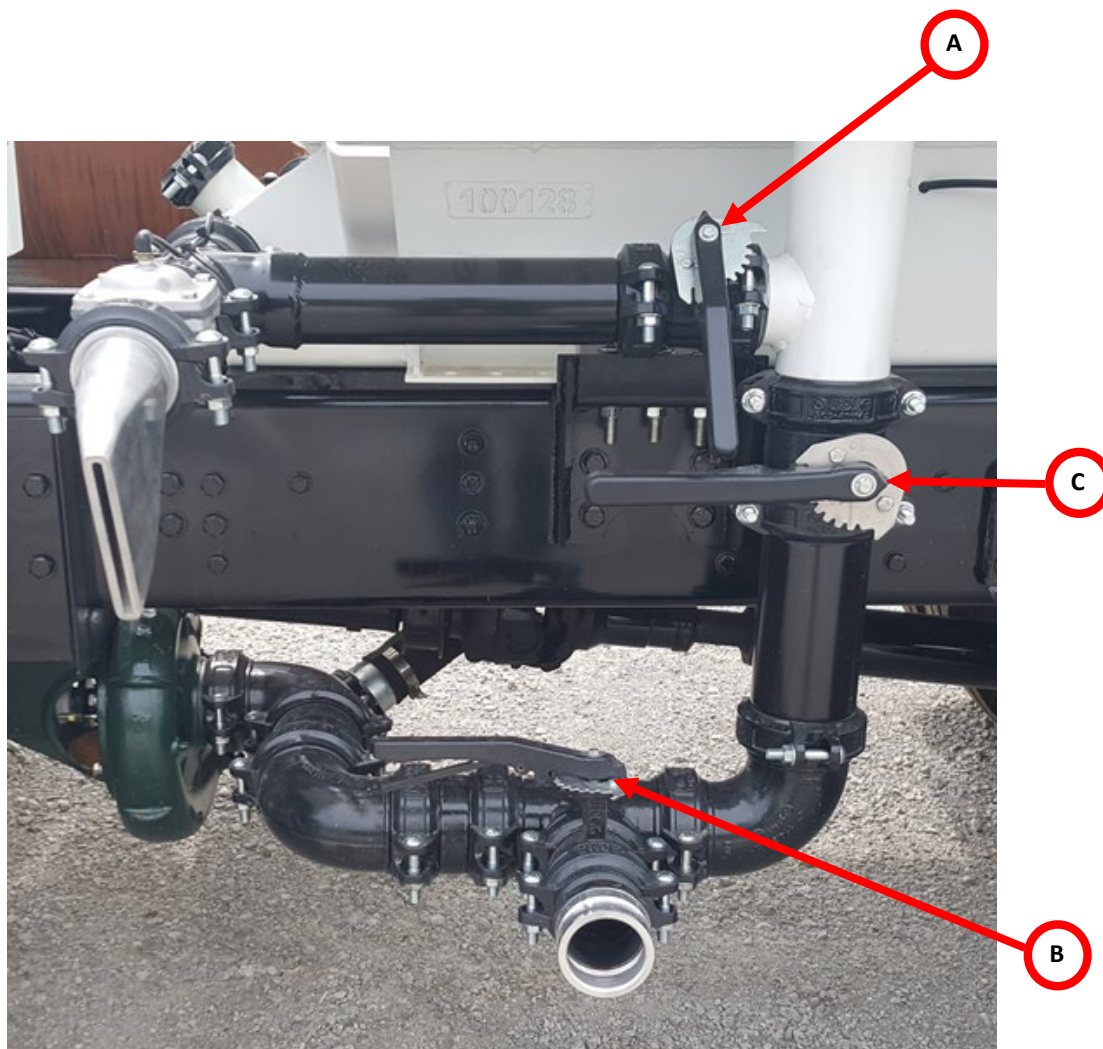

Post Operation Inspection

1. Complete a 360 degree walk around to ensure there has been no damage to the water tank during operation.
2. Visually inspect all critical components and fasteners to ensure they were not damaged or loosened during operations.

SAFETY INFORMATION



For the operator's protection, there are warning labels and safety devices on the Load King Water Truck that are **NOT** to be tampered with or removed. It is important for the operator to read all warning labels before operating the Load King Water Truck. It is the owner's responsibility to ensure that the operator and workers on and around the Water Truck understand all of the safety warnings herein and affixed to the machine. **Do not operate Water Truck if safety labels are missing or damaged**



1. WARNING: The warning and safety labels must be legible. These labels must not be removed or altered in anyway. These labels are important directions to ensure that neither workers, nor the water tank get damaged during working operations or traveling. The pictures in the following section show the decals and their locations. Operating the unit with illegible or missing safety labels is a direct violation of the intended use of the unit and voids the warranty.



2. DANGER: Keep all body parts away from moving parts. Do not attempt to manually stop or restrain any moving parts.



3. DANGER: This water tank is a piece of heavy machinery and should be treated as such. Do not operate while fatigued, under the influence of any medication which may impair your ability to operate the machinery safely, or while otherwise impaired.



4. DANGER: Always be aware of your surroundings when operating water tank. Do not operating in crowded areas, or areas of high traffic.



5. WARNING: Do not overload. Be mindful of Gross Vehicle Weight Rating of your truck, as well as local laws regarding vehicle weight in your area, and be mindful of the effects of increased payload weight on the driving characteristics of your vehicle.



6. CAUTION: Do not drive truck with PTO engaged. This may result in serious damage to chassis and hydraulic systems.

7. Load king is not responsible for any loss or damage resulting from operators neglect of the safety information provided.

LOAD KING WATER TANK LABELS

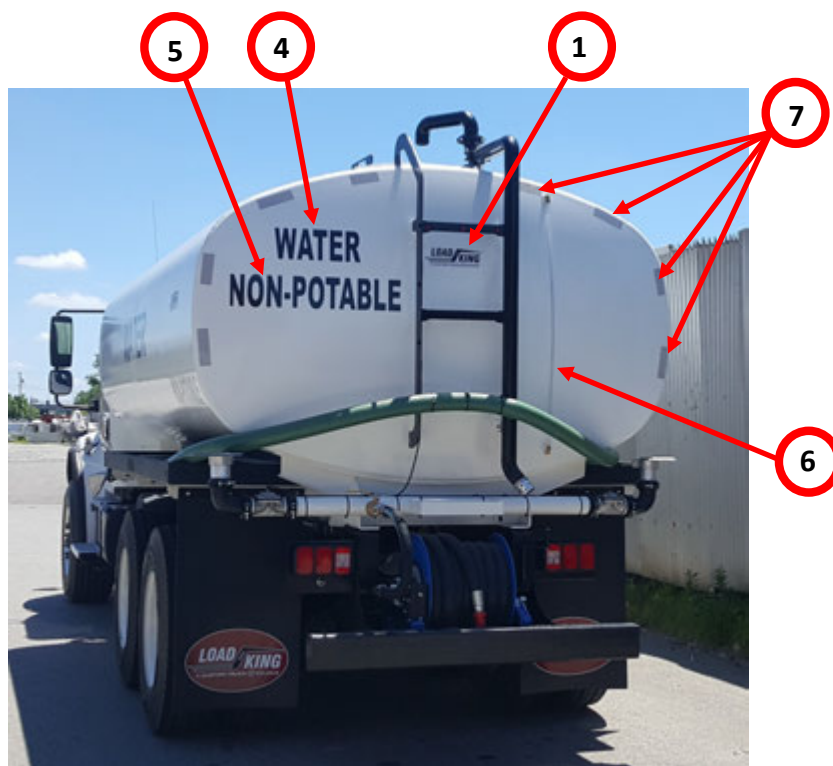

KEY	DESCRIPTION	QTY.
1	LOAD KING LOGO DECAL	3
2	CREEK FILL DECAL	1
3	10" x 43" WATER DECAL	2
4	6" x 22" WATER DECAL	1
5	NON-POTABLE DECAL	3
6	TANK FILL GUAGE DECAL	1
7	WHITE CONSPICUITY TAPE	4FT

LOAD KING WATER TANK LABELS



1

LOAD KING
BY CUSTOM TRUCK SOURCE

SUCTION LOAD TANK:
OPEN VALVE - A & B
CLOSE VALVE - C

SPRAY OPERATION:
OPEN VALVE - C
CLOSE VALVE - A & B

Creek fill hook up steps:
Have some water in the tank and go to your creek fill location..

- Step 1 Hook up your creek hose
- Step 2 Close valve B
- Step 3 Open A & C
- Step 4 Slowly open B and let the inlet line fill with water and it starts to flow
- Step 5 Activate PTO
- Step 6 Slowly close valve C and tank will begin to fill

Note: If the pump is dripping water it is still acceptable because pump has rope packing

2

WATER

3

WATER

4

NON-POTABLE

5



6

LUBRICATION AND MAINTAINANCE

Lubricate grease zerks on pump bearing (2 total). *Locations shown below*

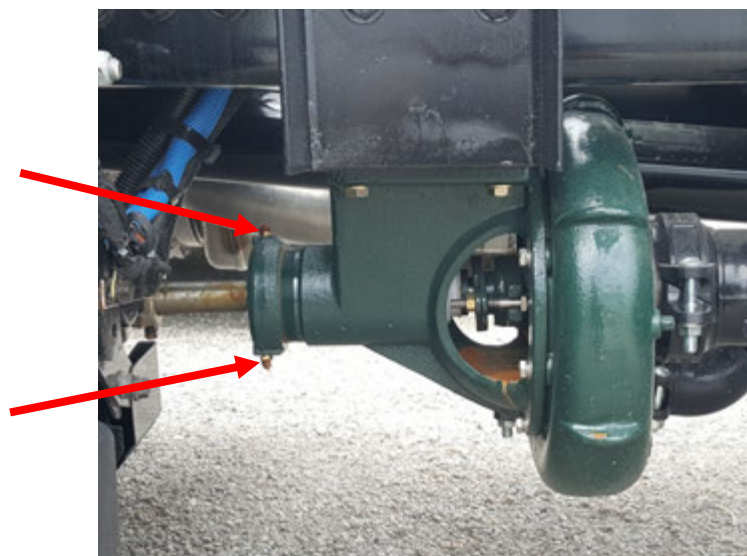
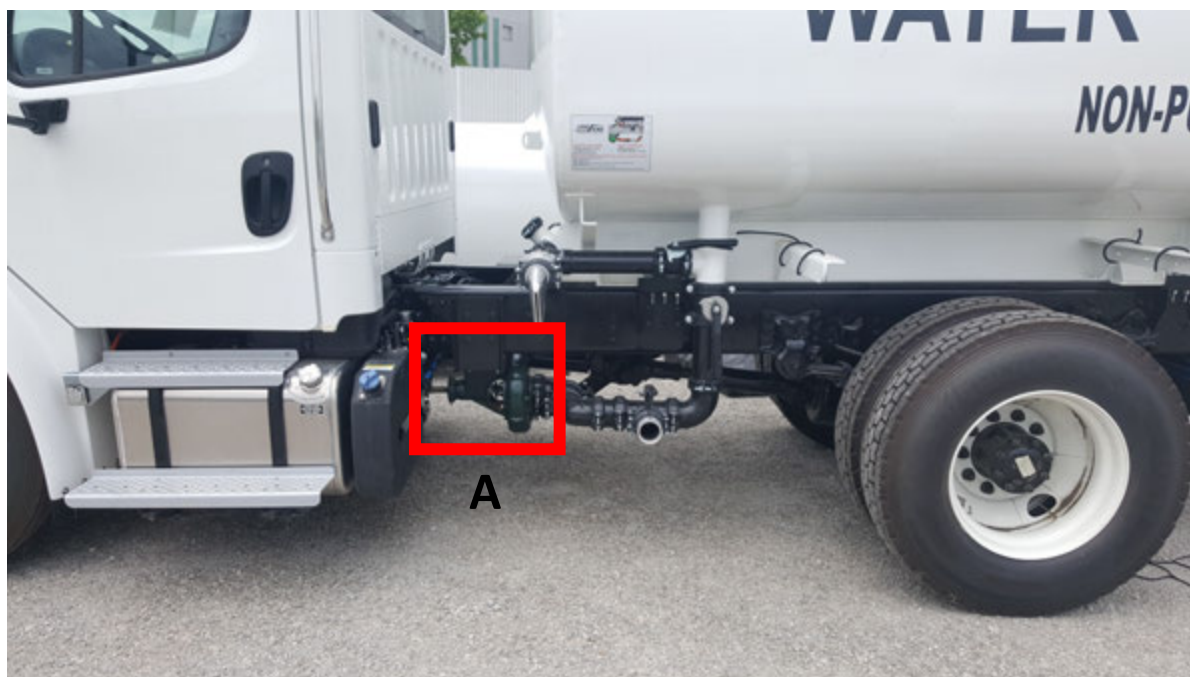

DETAIL A

LUBRICATION AND MAINTAINANCE (CONT.)

Lubricate grease zerks on PTO drive shaft (3 total). *Locations shown below*

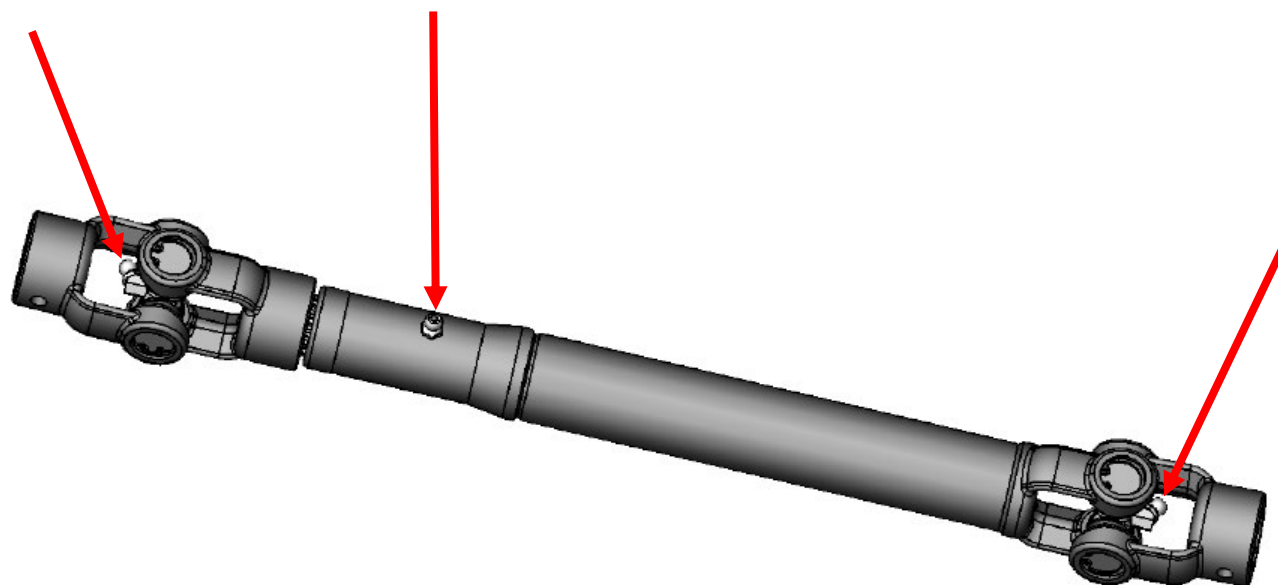

CAUTION: ALL grease zerks are to be topped off prior to first use and every month following.

LOAD KING WARRANTY

Load King (herein after referred to as the COMPANY) warrants all products manufactured by it and purchased by you to be free from defects in material and manufacture at the time of shipment, for one (1) year from date of delivery. The COMPANY will furnish replacements for such parts as the COMPANY finds to have been defective at the time of delivery or, at the COMPANY's option, will make or authorize repairs to such parts, provided that, upon request, such parts are returned, transportation is prepaid to the factory from which they were shipped.

This warranty shall not apply to any Product which has been subjected to misuse, misapplication, overloading, neglect (including but not limited to use of unauthorized parts or attachments), adjustments or repair. Engines, motor, tires, wheels, suspensions, axles, etc. and any accessories furnished with or used in the COMPANY's products, but which are not manufactured by the COMPANY, are not warranted by the COMPANY but are sold only with the express warranty, if any, or the manufacturers thereof. This warranted is limited to the first purchaser/user and is not transferable.

THE FOREGOING IS IN LIEU OF ALL OTHER WARRANTIES, WHETHER EXPRESSED OR IMPLIED (INCLUDING, WITHOUT LIMITATIONS, OF MERCHANTABILITY AND FITNESS OF ANY PRODUCT FOR A PARTICULAR PURPOSE), AND OF ANY OTHER OBLIGATION OR LIABILITY ON THE PART OF THE COMPANY. THERE ARE NO WARRANTIES WHICH EXTEND BEYOND THE DESCRIPTION OF THE FACE THEREOF.

LIMITATION OF LIABILITY

It is expressly understood and agreed by you that the COMPANY's liability for its products, whether due to breach of warranty, or otherwise is limited to the furnishing of such replacement parts, F.O.B.

factory, and the COMPANY will not be liable for any other injury, loss, damage, or expense, whether direct or consequential, including but not limited to loss of use, income, profit, or production, injury to person or increase in cost of operation, spoilage of or damage to material, arising out of or in connection with the sale, installation, use or inability to use, or the repair or replacement of the COMPANY's products.

All used vehicles and/or bodies are sold in the "AS IS" condition and no expressed or implied warranty is made.

All of COMPANY'S Products are of high quality and are manufactured in conformity with the best commercial practices in the various lines. The COMPANY guarantees all Products manufactured by it to be free from defects in material and manufactured at the time of shipment, for one (1) year from date of delivery. In addition, the COMPANY guarantees the portion of the product to be considered structural for one (1) year from date of manufacture.

While Load King, LLC. designs and manufactures its specific equipment configurations to industry standards, it is ultimate responsibility of the buyer/operator to assure that all loads are properly loaded and distributed. All loads must comply with the applicable state and federal load limits.

LOAD KING WARRANTY DATA RECORD

Water Tank Warranty Form Submission		Date	
Date of Delivery			
Model Number			
S/N			
Dealer			
Address			
Customer			
Address			

Record this information at the time that warranty registration form is completed and returned to Load King

REVISION CONTENT

REVISION	DATE	DESCRIPTION	LOCATION
A	07/02/18	INITIAL RELEASE	



Load King

PO Box 427

Elk Point, South Dakota, USA 57025-0427

Toll Free: (888) 264-5522